

Data sheet | Item number: 750-304
 Fieldbus Coupler INTERBUS

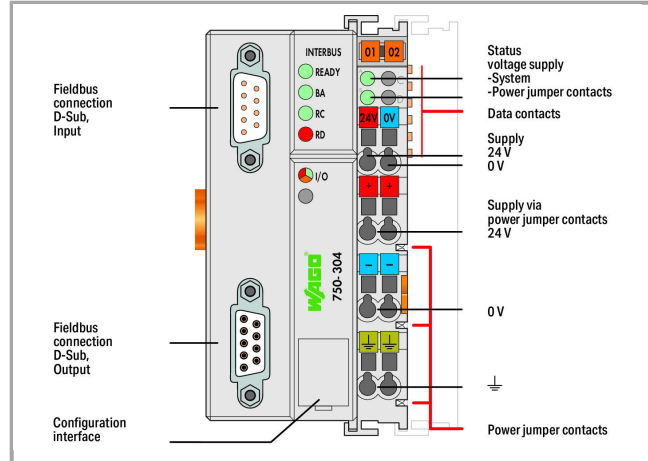

750-304



RoHS Compliant

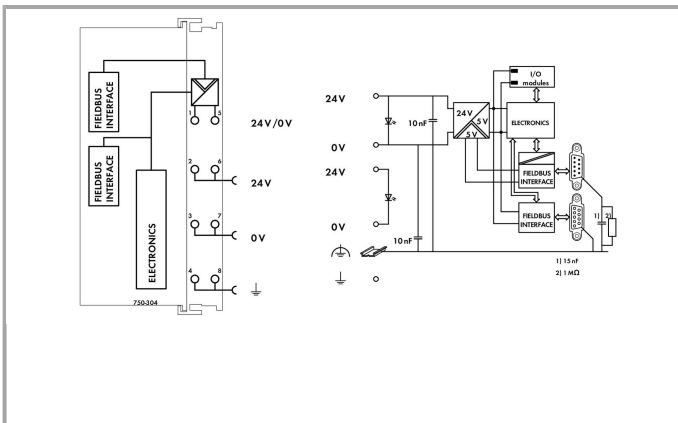

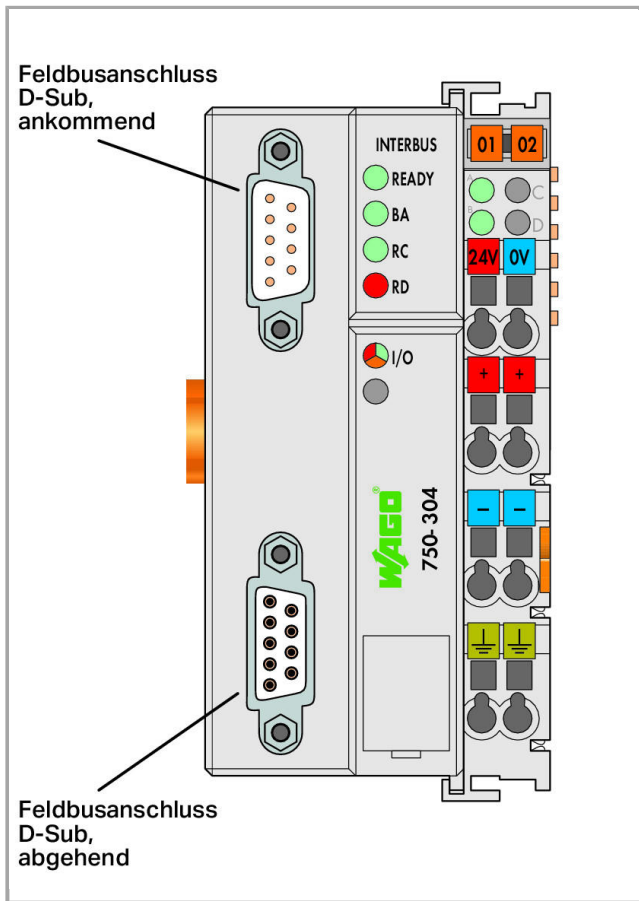

Item description

This buscoupler connects the WAGO-I/O-SYSTEM as a slave to the INTERBUS fieldbus.

The buscoupler automatically configures, creating a local process image which may include analog, digital or specialty modules. Analog and specialty module data is sent via words and/or bytes, digital data is sent bit by bit.

INTERBUS stores the process image in the corresponding Master control (PLC, PC or NC).

The local process image is divided into two data zones containing the data received and the data to be sent. The process data can be sent via the INTERBUS fieldbus to the PLC, PC or NC for further processing, and received from the field via INTERBUS. The process data can be sent via the INTERBUS fieldbus to the PLC, PC or NC for further processing, and received from the field via INTERBUS.

The data of the analog modules is stored in the process image which is created automatically according to the order in which the modules are connected to the buscoupler. The bits of the digital modules are sent byte by byte and added to the analog data. If the amount of digital information exceeds 8 bits, the buscoupler automatically starts with a new byte.

Data

Technical Data

Communication	INTERBUS
Number of fieldbus nodes on the master max.	256
Max. no. of I/O points	4096



Baud rate	500 kBd
Fieldbus segment length max.	400 m
Transmission medium	Certified Cu cable
Transmission time	typ. 1.43 ms (10 couplers; 32 digital I/Os per coupler)
Number of modules per node max.	64
Input and output process image (Fieldbus) max.	64 Byte/64 Byte
System supply voltage	DC 24 V(-15 ... +20 %); via wiring level (CAGE CLAMP® connection)
Current consumption, system supply (5 V)	300 mA
Total current for system supply	1700 mA
System and sensor supply voltage)
Field supply voltage	DC 24 V (-15 ... +20 %); via power jumper contacts
Input current typ. at rated load (24 V)	500 mA
Efficiency of the power supply (typ.) at nominal load (24 V)	87 %
Isolation	500 V system/supply
Number of outgoing power jumper contacts	3
Current carrying capacity of the power jumper contacts	10 A
Certification	INTERBUS CLUB
Standard	EN 50254

Connection data

Connection technology: communication/fieldbus	INTERBUS: 1 x D-Sub 9 plug / D-Sub 9 socket
Connection technology: field supply	6 x CAGE CLAMP®
Connection technology: system supply	2 x CAGE CLAMP®
Connection technology: Device configuration	1 x 4-pole male connector
Connection type (1)	System/field supply
Solid conductor	0.08 ... 2.5 mm ² / 28 ... 14 AWG
Fine-stranded conductor	0.08 ... 2.5 mm ² / 28 ... 14 AWG
Strip length	8 ... 9 mm / 0.31 ... 0.35 inch

Geometrical Data

Width	50.5 mm / 1.988 inch
Height	71.1 mm / 2.799 inch
Height from upper-edge of DIN-35 rail	63.9 mm / 2.516 inch
Depth	100 mm / 3.937 inch

Mechanical data

Type of mounting	DIN-35 rail
------------------	-------------

Material Data

Color	light gray
Housing material	Polycarbonate, polyamide 6.6
Weight	187 g
Conformity marking	1

Environmental Requirements

Surrounding air (operating) temperature	0 ... 55 °C
Surrounding air (storage) temperature	-40 ... 85 °C
Protection class	IP20
Degree of pollution (5)	2 per IEC 61131-2
Operating altitude	0 ... 2000 m
Mounting position	horizontal (standing/lying) or vertical
Relative air humidity (no condensation)	95 %
Vibration resistance	acc. to IEC 60068-2-6
Shock resistance	15g per IEC 60068-2-27
EMC immunity to interference	acc. to EN 61000-6-2
EMC emission of interference	acc. to EN 61000-6-4
Exposure to pollutants	Per IEC 60068-2-42 and IEC 60068-2-43
Permissible H ₂ S contaminant concentration at a relative humidity 75 %	10 ppm
Permissible SO ₂ contaminant concentration at a relative humidity 75 %	25 ppm

Commercial data

Product Group	15 (Remote I/O)
Country of origin	DE
GTIN	4045454526405
Customs Tariff No.	8517620000

Approvals / Certificates

Ex-Approvals

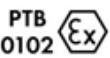
Logo	Approval	Additional Approval Text	Certificate name
	ATEX TUEV Nord Cert GmbH	EN 60079-0	TÜV 07 ATEX 554086 X en.
	TUEV Nord TUEV Nord Cert GmbH	IEC 60079-0	IECEX TUN





UL
Underwriters Laboratories Inc. (HAZARDOUS
LOCATIONS)

ANSI/ISA 12.12.01

E198726
Sec.1

Country specific Approvals

Logo	Approval	Additional Approval Text	Certificate name
	KC National Radio Research Agency	Article 58-2, Clause 3	MSIP- REM-W43- FBC750
	KC National Radio Research Agency	Article 58-2, Clause 3	MSIP- REM-W43- FBC750

UL-Approvals















Logo	Approval	Additional Approval Text	Certificate name
	UL UL International Netherlands B.V. (ORDINARY LOCATIONS)	UL 508	E175199 Sec.1

















Compatible products

General accessories

	Item no.: 750-921 Bluetooth® Adapter		750-921
	Item no.: 750-923 Configuration cable; USB connector; Length: 2.5 m		750-923
	Item no.: 750-923/000-001 Configuration cable; USB connector; Length: 5 m		750-923

Marking accessories

	Item no.: 2009-145 Mini-WSB Inline; for Smart Printer; on reel; stretchable 5 - 5.2 mm; plain; snap-on type		2009-145
	Item no.: 2009-145/000-002 Mini-WSB Inline; for Smart Printer; on reel; stretchable 5 - 5.2 mm; plain; snap-on type	/000-002	2009-145
	Item no.: 2009-145/000-005 Mini-WSB Inline; for Smart Printer; on reel; stretchable 5 - 5.2 mm; plain; snap-on type	/000-005	2009-145
	Item no.: 2009-145/000-006 Mini-WSB Inline; for Smart Printer; on reel; stretchable 5 - 5.2 mm; plain; snap-on type	/000-006	2009-145
	Item no.: 2009-145/000-007 Mini-WSB Inline; for Smart Printer; on reel; stretchable 5 - 5.2 mm; plain; snap-on type	/000-007	2009-145
	Item no.: 2009-145/000-012 Mini-WSB Inline; for Smart Printer; on reel; stretchable 5 - 5.2 mm; plain; snap-on type	/000-012	2009-145
	Item no.: 2009-145/000-023 Mini-WSB Inline; for smartPRINTER; on reel; stretchable 5 - 5.2 mm; plain; snap-on type	/000-023	2009-145
	Item no.: 2009-145/000-024 Mini-WSB Inline; for Smart Printer; on reel; stretchable 5 - 5.2 mm; plain; snap-on type	/000-024	2009-145
	Item no.: 248-501 Miniature WSB Quick marking system; plain; Marker width 5 mm; 10 strips with 10 markers per card		248-501
	Item no.: 248-501/000-002 Mini-WSB marking card; as card; not stretchable; plain; snap-on type	/000-002	248-501
	Item no.: 248-501/000-005 Mini-WSB marking card; as card; not stretchable; plain; snap-on type	/000-005	248-501
	Item no.: 248-501/000-006 Mini-WSB marking card; as card; not stretchable; plain; snap-on type	/000-006	248-501
	Item no.: 248-501/000-007 Mini-WSB marking card; as card; not stretchable; plain; snap-on type	/000-007	248-501
	Item no.: 248-501/000-012 Mini-WSB marking card; as card; not stretchable; plain; snap-on type	/000-012	248-501
	Item no.: 248-501/000-017 Mini-WSB marking card; as card; not stretchable; plain; snap-on type	/000-017	248-501

	Item no.: 248-501/000-023 Mini-WSB marking card; as card; not stretchable; plain; snap-on type	248-501 /000-023
	Item no.: 248-501/000-024 Mini-WSB marking card; as card; not stretchable; plain; snap-on type	248-501 /000-024
	Item no.: 750-100 Marker card; as a DIN A4 sheet; plain	750-100
	Item no.: 750-103 Group marker carrier	750-103
	Item no.: 750-106 Group marker carrier	750-106
shield connection		
	Item no.: 790-108 Shield clamping saddle; 11 mm wide; diameter of compatible conductor	790-108
	Item no.: 790-116 Shield clamping saddle; 19 mm wide; diameter of compatible conductor; 7 ... 16 mm	790-116
	Item no.: 790-124 Shield clamping saddle; 27 mm wide; diameter of compatible conductor; 6 ... 24 mm	790-124
	Item no.: 790-140 Shield clamping saddle; diameter of compatible conductor	790-140
	Item no.: 790-208 Shield clamping saddle; 12.4 mm wide; 3 ... 8 mm	790-208
	Item no.: 790-216 Shield clamping saddle; 21.8 mm wide; 6 ... 16 mm	790-216
	Item no.: 790-220 Shield clamping saddle; 30 mm wide; 6 ... 20 mm	790-220
wiring and connectors		
	Item no.: 750-961 INTERBUS fieldbus connector (IN); with D-sub female connector; 9-pole	750-961
	Item no.: 750-962 INTERBUS fieldbus connector (OUT); with D-sub male connector; 9-pole	750-962
system box		
	Item no.: 850-804 IP65 enclosure; Stainless steel; WxHxD (400x123x200 mm); 4 x M20, 16 x M16, 28 x M12 cable grip	850-804
	Item no.: 850-804/000-001 IP65 enclosure; Stainless steel; WxHxD (400x123x200 mm); 2 x M20, 13 x M16, 32 x M12 cable grip	850-804 /000-001
	Item no.: 850-805 IP65 enclosure; Stainless steel; WxHxD (600x123x200 mm); 4 x M20, 19 x M16, 67 x M12 cable grip	850-805
	Item no.: 850-814/002-000 IP65 enclosure; Sheet steel (RAL 7035); WxHxD (200x120x200 mm); without flange plate	850-814 /002-000

**Item no.: 850-815/002-000**

IP65 enclosure; Sheet steel (RAL 7035); WxHxD (300x120x200 mm); without flange plate

/002-000

850-815

**Item no.: 850-816/002-000**

IP65 enclosure; Sheet steel (RAL 7035); WxHxD (400x120x200 mm); without flange plate

/002-000

850-816

**Item no.: 850-817/002-000**

IP65 enclosure; Sheet steel (RAL 7035); WxHxD (600x120x200 mm); without flange plate

/002-000

850-817

**Item no.: 850-825**

IP65 enclosure; Aluminium (RAL 7032); WxHxD (160x100x160 mm); 9 x M12, 4 x M20

850-825

**Item no.: 850-826**

IP65 enclosure; Aluminium (RAL 7032); WxHxD (240x100x160 mm); 4 x M20, 4 x M16, 14 x M12 cable grip

850-826

**Item no.: 850-826/002-000**

IP65 enclosure; Aluminium (RAL 7035); WxHxD (240x100x160 mm); 4 x M20, 4 x M16, 14 x M12 cable grip

/002-000

850-826

**Item no.: 850-827**

IP65 enclosure; Aluminium (RAL 7032); WxHxD (320x100x160 mm); 4 x M20, 8 x M16, 17 x M12 cable grip

850-827

**Item no.: 850-827/002-000**

IP65 enclosure; Aluminium (RAL 7035); WxHxD (320x100x160 mm); 4 x M20, 8 x M16, 17 x M12 cable grip

/002-000

850-827

**Item no.: 850-828**

IP65 enclosure; Aluminium (RAL 7032); WxHxD (480x100x160 mm); 4 x M20, 10 x M16, 35 x M12 cable grip

850-828

**Item no.: 850-828/002-000**

IP65 enclosure; Aluminium (RAL 7035); WxHxD (480x100x160 mm); 4 x M20, 10 x M16, 35 x M12 cable grip

/002-000

850-828

**Item no.: 850-834**

IP65 enclosure; Polyester (RAL 7032); WxHxD (164x100x164 mm); 9 x M12, 4 x M20

850-834

**Item no.: 850-835**

IP65 enclosure; Polyester (RAL 7032); WxHxD (244x100x164 mm); 4 x M20, 4 x M16, 14 x M12 cable grip

850-835

**Item no.: 850-836**

IP65 enclosure; Polyester (RAL 7032); WxHxD (324x100x164 mm); 4 x M20, 8 x M16, 17 x M12 cable grip

850-836

Carrier rail**Item no.: 210-112**

Steel carrier rail; 35 x 7.5 mm; 1 mm thick; 2 m long; slotted; according to EN 60715; "Hole width 25 mm

210-112

**Item no.: 210-113**

Steel carrier rail; 35 x 7.5 mm; 1 mm thick; 2 m long; unslotted; according to EN 60715

210-113

	Item no.: 210-114 Steel carrier rail; 35 x 15 mm; 1.5 mm thick; 2 m long; unslotted; similar to EN 60715	210-114
	Item no.: 210-115 Steel carrier rail; 35 x 7.5 mm; 1 mm thick; 2 m long; slotted; according to EN 60715; "Hole width 18 mm	210-115
	Item no.: 210-118 Steel carrier rail; 35 x 15 mm; 2.3 mm thick; 2 m long; unslotted; according to EN 60715	210-118
	Item no.: 210-196 Aluminum carrier rail; 35 x 8.2 mm; 1.6 mm thick; 2 m long; unslotted; similar to EN 60715	210-196
	Item no.: 210-197 Steel carrier rail; 35 x 15 mm; 1.5 mm thick; 2 m long; slotted; similar to EN 60715	210-197
	Item no.: 210-198 Copper carrier rail; 35 x 15 mm; 2.3 mm thick; 2 m long; unslotted; according to EN 60715	210-198
	Item no.: 210-504 Steel carrier rail; 35 x 7.5 mm; 1 mm thick; 2 m long; slotted; galvanized; according to EN 60715	210-504
	Item no.: 210-505 Steel carrier rail; 35 x 7.5 mm; 1 mm thick; 2 m long; unslotted; galvanized; according to EN 60715	210-505
	Item no.: 210-506 Steel carrier rail; 35 x 15 mm; 1.5 mm thick; 2 m long; unslotted; galvanized; similar to EN 60715	210-506
	Item no.: 210-508 Steel carrier rail; 35 x 15 mm; 1.5 mm thick; 2 m long; slotted; galvanized; similar to EN 60715	210-508

Downloads

Documentation

Manual			
INTERBUS Fieldbus Coupler EN 50254, fiber-optic connection, digital and analog signals	V 2.2.2	pdf 4.5 MB	Download
Bid Text			
750-304 IO, Koppler	Oct 2, 2014	doc 29.7 kB	Download
Additional Information			
Disposal; Electrical and electronic equipment, Packaging	V 1.0.0	pdf 265.8 kB	Download
System Description			
Use in Hazardous Environments Term definition, marking and installation regulations	V 1.0.0	pdf 1.0 MB	Download
Design Notes	V 2.0.0	pdf	Download



Basic conditions and recommendations for higher operational safety	1.5 MB	
750/753 Series I/O-System – General Product Information	pdf 1.7 MB	Download
Overview on WAGO-I/O-SYSTEM 750 approvals	pdf 780.2 kB	Download

Runtime Software

Firmware

Firmware: 750-304 Fieldbus Coupler INTERBUS	06 Mar 28, 2019	zip 411.9 kB	Download
---	--------------------	-----------------	----------

CAD/CAE - Smart Data

CAD data

3D Download 750-304	URL	Download
---------------------	-----	----------

Device Files

Device Driver

WAGO USB Service Cable Driver / 750 and 857 Series 759-923	6.5.3.0 Sep 10, 2014	zip 4.8 MB	Download
---	-------------------------	---------------	----------

Product family

750/753 Series I/O-System
[Learn more about the product family.](#)

[Show all products from the family](#)

Subject to changes.